



# LIVIN HILL

## ASSEMBLY INSTRUCTIONS & PARTS IDENTIFICATION MODEL # 2295 - 96KD ARCHDALE 6 DOOR ACCENT CABINET BLACK FINISH

### Parts key

No	Code	Qty	Description	No	Code	Qty	Description
1	2295-96KDP54	1 pc	Top	8	2295-96KDP38S	3 pcs	Back Panel
2	2295-96KDP51B	1 pc	Bottom Shelf	9	2295-96KDP07L	3 pcs	Left Side Facing End Door
3	2295-96KDP53	1 pc	Front Frame				
4	2295-96KDP51L	1 pc	Left Side Facing Side Panel	10	2295-96KDP07R	3 pcs	Right Side Facing End Door
5	2295-96KDP51R	1 pc	Right Side Facing Side Panel	11	2295KDP51H	6 pcs	Side Panel Hinge
				12	2295KDP07H	12 pcs	Door Hinge
6A	2295-96KDP08VL	1 pc	Vertical Partition Left	13	2295KDP01L	4 pcs	Leveler
6B	2295-96KDP08VR	1 pc	Vertical Partition Right	14	2295KDP01D	3 pcs	Door Catch
7	2295-96KDP08S	3 pcs	Shelf	15	2295KDP02M	2 pcs	Middle leg
				16	2295KDP01AT	1 set	Anti-Tip Kit

### Hardware Kit 2295-96KDP01

No	Code	Qty	Description	No	Code	Qty	Description
17	2295KDP08P	12 pcs	Shelf Pin	19	2295KDP01S	12 pcs	Wood Screw
18	2295KDP04	6 pcs	Handle w/ Screw	20	2295KDP01WD	2 pcs	Wood Dowel

**PLEASE NOTE:** Assembly requires two people. Follow directions step by step.

#### Step:01

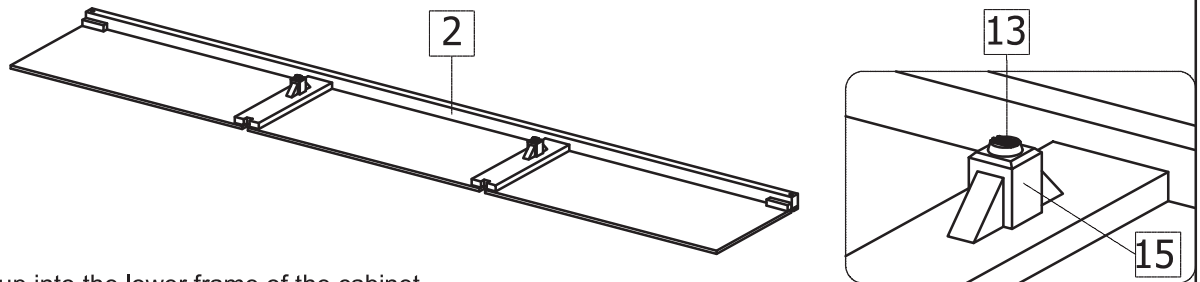

- The middle leg is set up into the lower frame of the cabinet.

#### Step:02

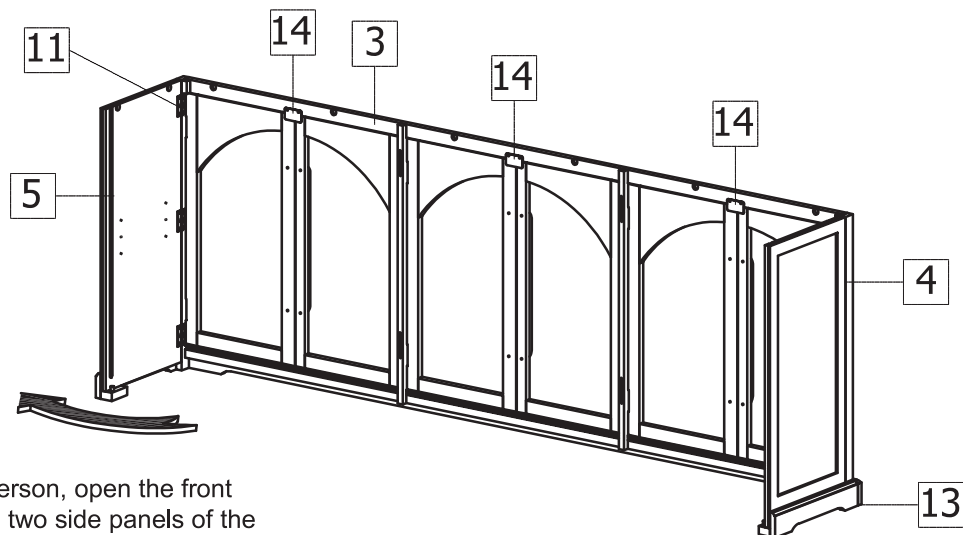

- With the help of the second person, open the front frame assembly positioning the two side panels of the cabinet 90° perpendicular to the cabinet frame.



# LIVIN HILL

## ASSEMBLY INSTRUCTIONS & PARTS IDENTIFICATION MODEL # 2295 - 96KD ARCHDALE 6 DOOR ACCENT CABINET BLACK FINISH

### Step:03

- Insert the wood dowels into the rear leg support

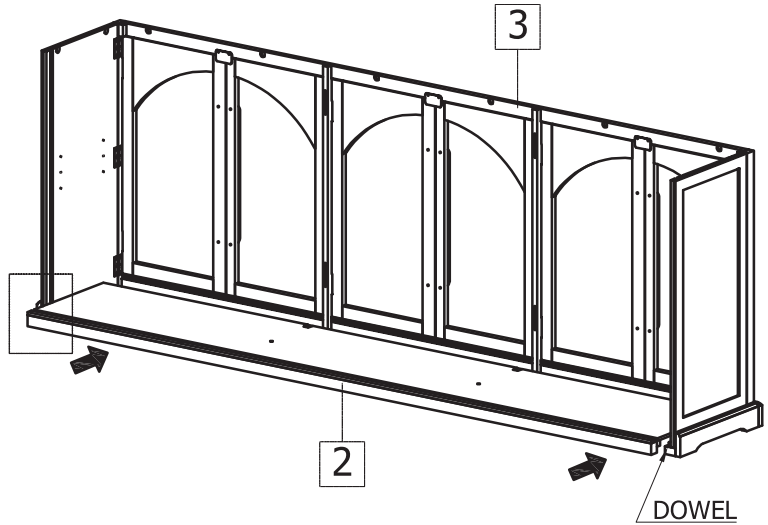
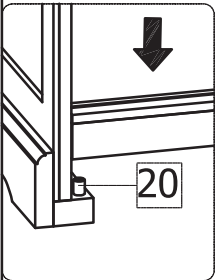

- Place the bottom shelf in position and lock the wood dowels into the receiving holes in the rear leg.

### Step:04

- Insert the Left and Right Vertical Partition by placing the tab on the panel into the receiver on the Front Frame and gently push down to lock into place. Make sure that the locking tab is in the opened position to insert into the bottom shelf.

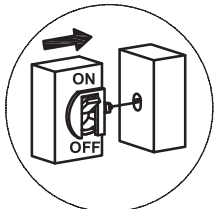
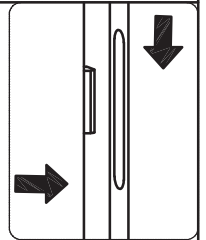
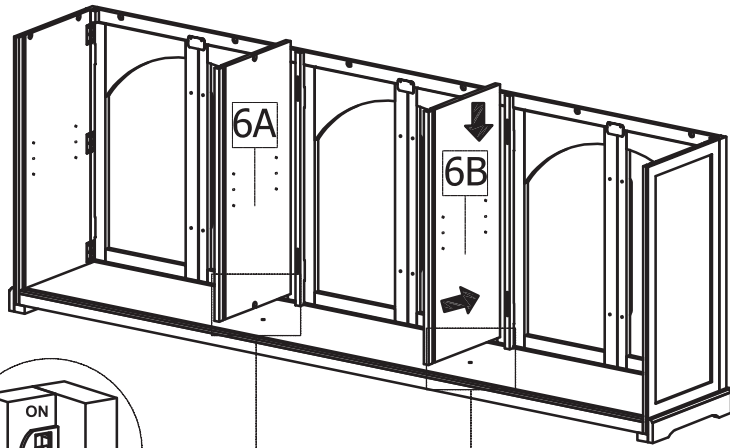

Tab in opened position

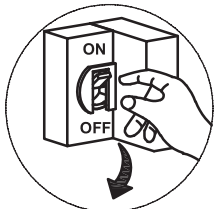

Pull tab down to lock



Tab in locked position

- Lock the tab ( see diagram below ) to secure the vertical panel to the bottom shelf

### Step:05

- Carefully insert the back panels into place making sure that the lock tabs are in the open position on the bottom of the back panel.

- Once in place, lock the tabs on the bottom.

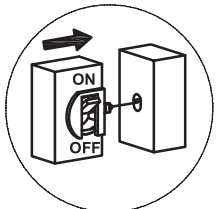
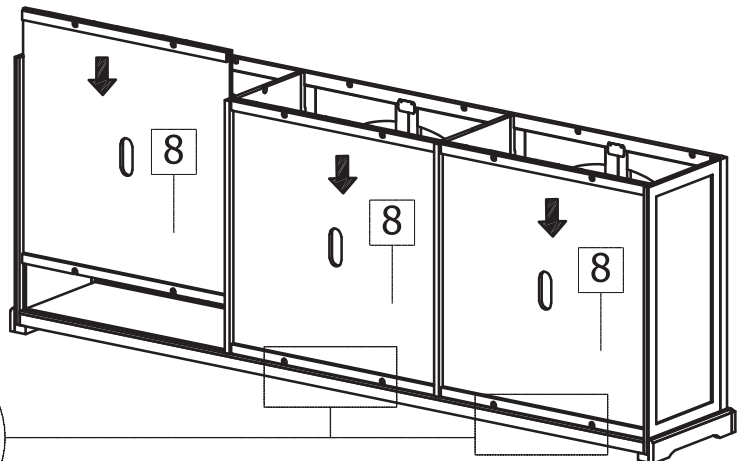

Tab in opened position

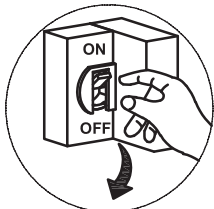

Pull tab down to lock

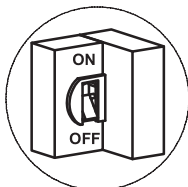

Tab in locked position



# LIVIN HILL

## ASSEMBLY INSTRUCTIONS & PARTS IDENTIFICATION MODEL # 2295 - 96KD ARCHDALE 6 DOOR ACCENT CABINET BLACK FINISH

### Step:06

- Line up all the locking tabs in the open position
- With two people, carefully align the top in place making sure that the tab fits into the receiver portion on the top. Once firmly in place, lock the tabs.

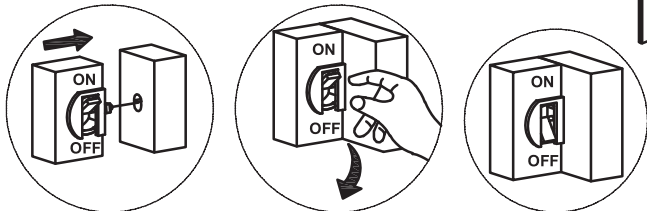
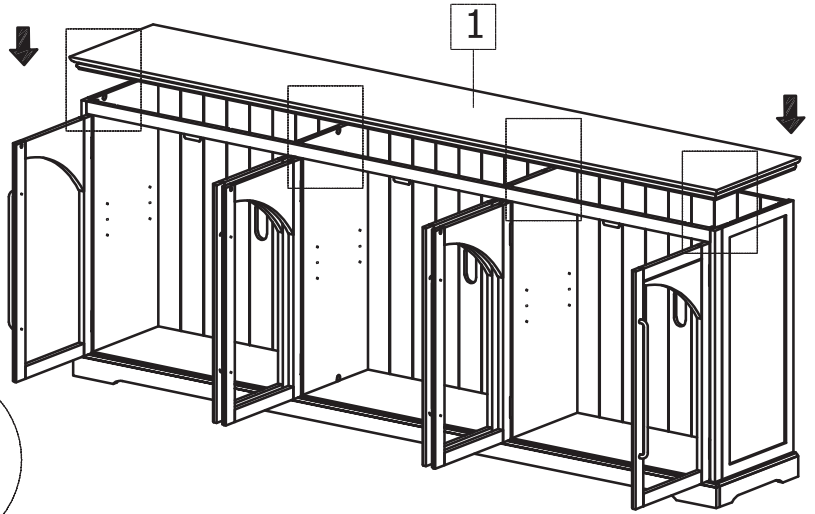

Tab in opened position    Pull tab down to lock    Tab in locked position

### Step:07

- Install the shelves using the shelf pins. it is important to secure the shelf in place with the wood screws ( See Diagram )
- Attach the door pull with a Phillips screwdriver as shown.

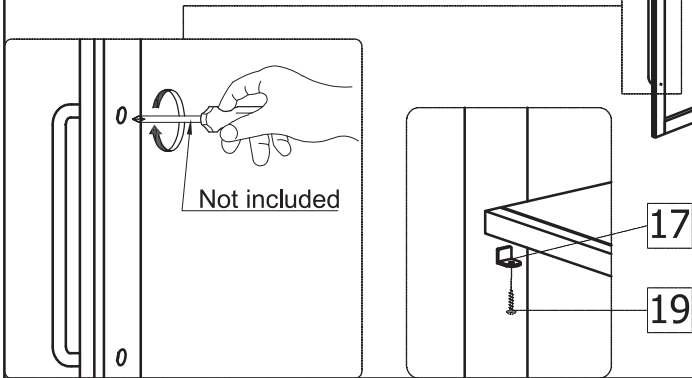
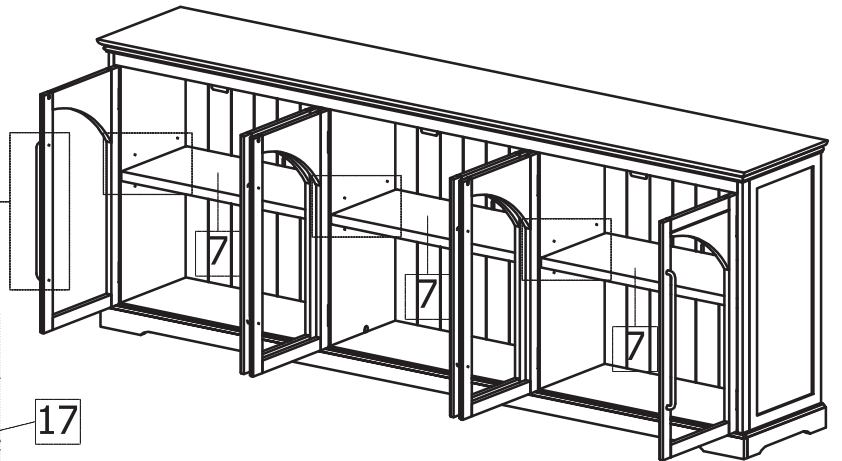

Not included

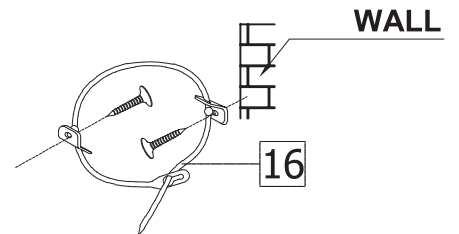
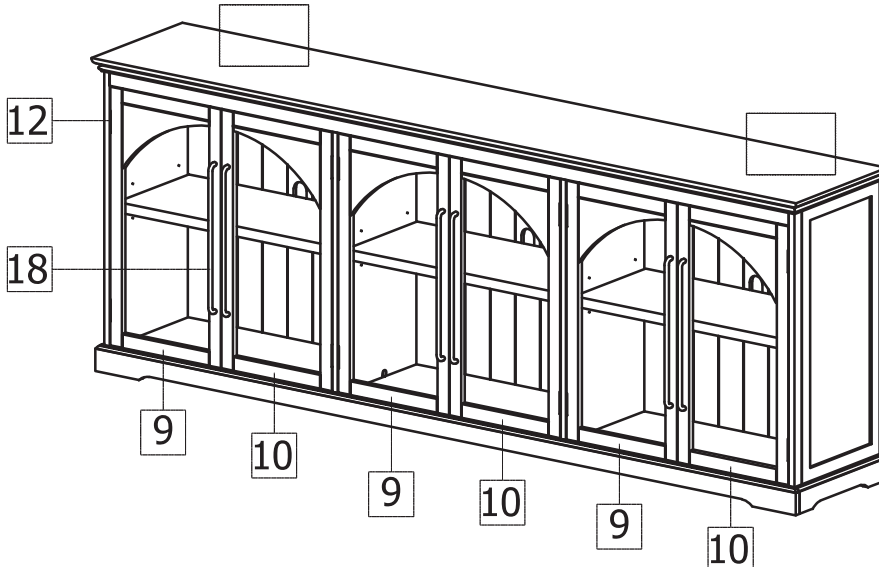

#### PLEASE NOTE :

To help prevent the possibility of tip-over, install the ANTI-TIP OVER restraint provided.